



Christie digital cinema projectors

XDC 3000 C

Digital Xenon Cinema C-type lamps are ideal for today's demanding 3D and 2D digital cinema presentations. They are especially designed for Christie projectors. There is a choice of four power ratings in the C-type Digital Cinema Xenon lamps range: 2000W, 3000W, 4500W, or 6000W. There is also a choice of three power ratings in the CH-type Digital Helios lamps range: 2000W, 3000W, and 4200W power ratings. All these lamps produce the very high light output needed to maximize screen brightness and enhance the dramatic effect for the viewer. These long-life digital lamps also provide constant color temperature characteristics, and meet all of the stringent arc-stability requirements for consistent customer satisfaction. In addition to C-type Digital Cinema Xenon lamps there are B-, N-, S-, and TA-type Digital Cinema Xenon lamps. These are all individually customized per projector, so there is a different, perfect-fitting lamp for each projector model to ensure optimized projector performance.

Product data

General Information	
Operating Position	P20 [Parallel +/-20D or Horizontal(HOR)]
Main Application	Cinema
Nominal Lifetime (Nom)	1500 h
Magnet	-

Operating and Electrical	
Power (Rated) (Nom)	3000 W
Lamp Current Span	90/120 A
Lamp Current (Nom)	110 A
Voltage (Nom)	29 V

Product Data	
Full product code	872790030163200
Order product name	XDC 3000 C
EAN/UPC - Product	8727900301632
Order code	928411706201
Numerator - Quantity Per Pack	1
Numerator - Packs per outer box	1
Material Nr. (12NC)	928411706201
Net Weight (Piece)	0.715 kg

Christie digital cinema projectors

Dimensional drawing

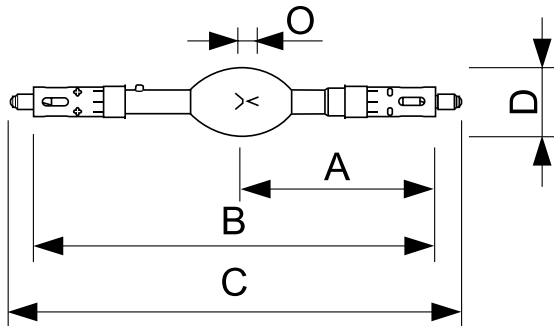

Product	O	D	B	C	A
XDC 3000 C	5.5 mm	60 mm	350 mm	403 mm	161.5 mm

LTIX XDC 3000W C

